



SCREAMIN' STUNT JAM™







ELECTRIC RACING SET

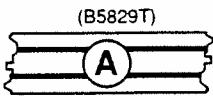

Keep these instructions for future reference, as they contain important information.

CONTENTS

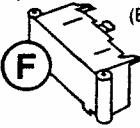
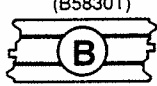
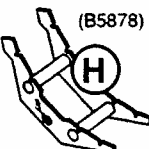
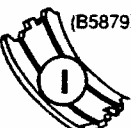
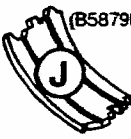

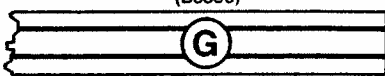
TRACK PIECES

 (B5829T) (3) 9 in. Straight Track	 (B5831) (3) 9 in. Radius Curve (1/4 circle)	 (B5831HW) (1) 9 in. Radius Curve (1/4 circle) w/Deco	 (B5877HW) (2) 9 in. Radius Curve Double rail w/Deco (1/4 Circle)	 (B5854A) (1) Jump Stand
 (B5830T) (2) 6 in. Straight Track	 (B5878) (4) Cradles	 (B5879XW) (4) Transitions	 (B5879HW) (8) Transitions (orange)	 (38111 - 9929) (1) Sound Unit/Terminal Track
				 (B5896) (1) 15 in. Jump Receiver

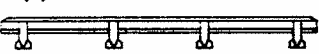
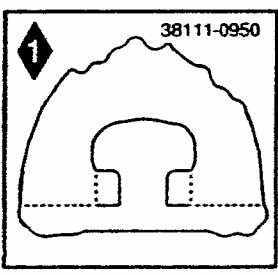
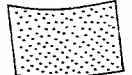
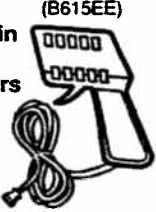
ACCESSORIES

 (B631) (1) Wall Power Pack	 (4) Guardrails (B7968)	 (1) Cardboard Backdrop (38111-0950)
 (1) Sandpaper (B7890)	 (2) Plug-in Racing Controllers (B615EE)	

VEHICLES

 (1) HOT WHEELS® 1940 Pickup
 (1) HOT WHEELS® Twin Mill® vehicle



Refer to the accompanying Owners Manual for wiring instructions for Power Pak and for assembly instructions for track, supports and accessory parts.

ALWAYS CLEAN TRACK RAILS AND TIRES BEFORE EACH RACE.

(See accompanying Owner's Manual for details.)

HOW TO ASSEMBLE JUMP

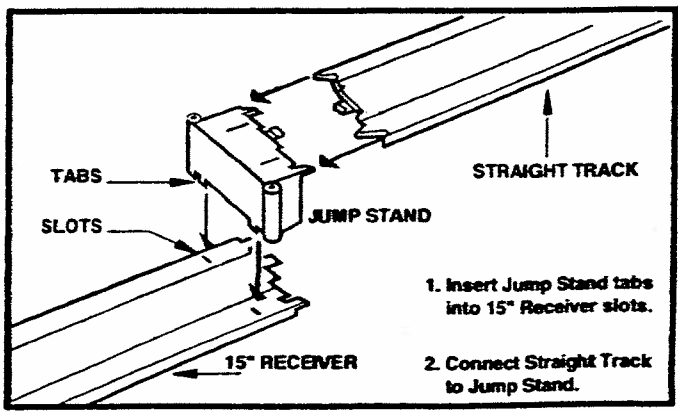

TRACK ASSEMBLY

Locate a convenient wall outlet and follow the diagram below to set up your track. All lettered parts in assembly diagram below are in the contents list on the reverse side.

NOTE: Refer to the Racing Manual for wiring instructions for track, supports and accessory pieces.

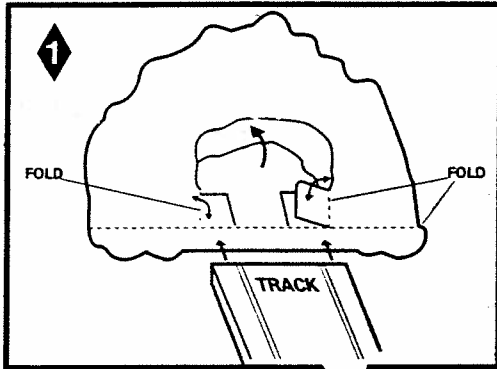

ASSEMBLE AS SHOWN

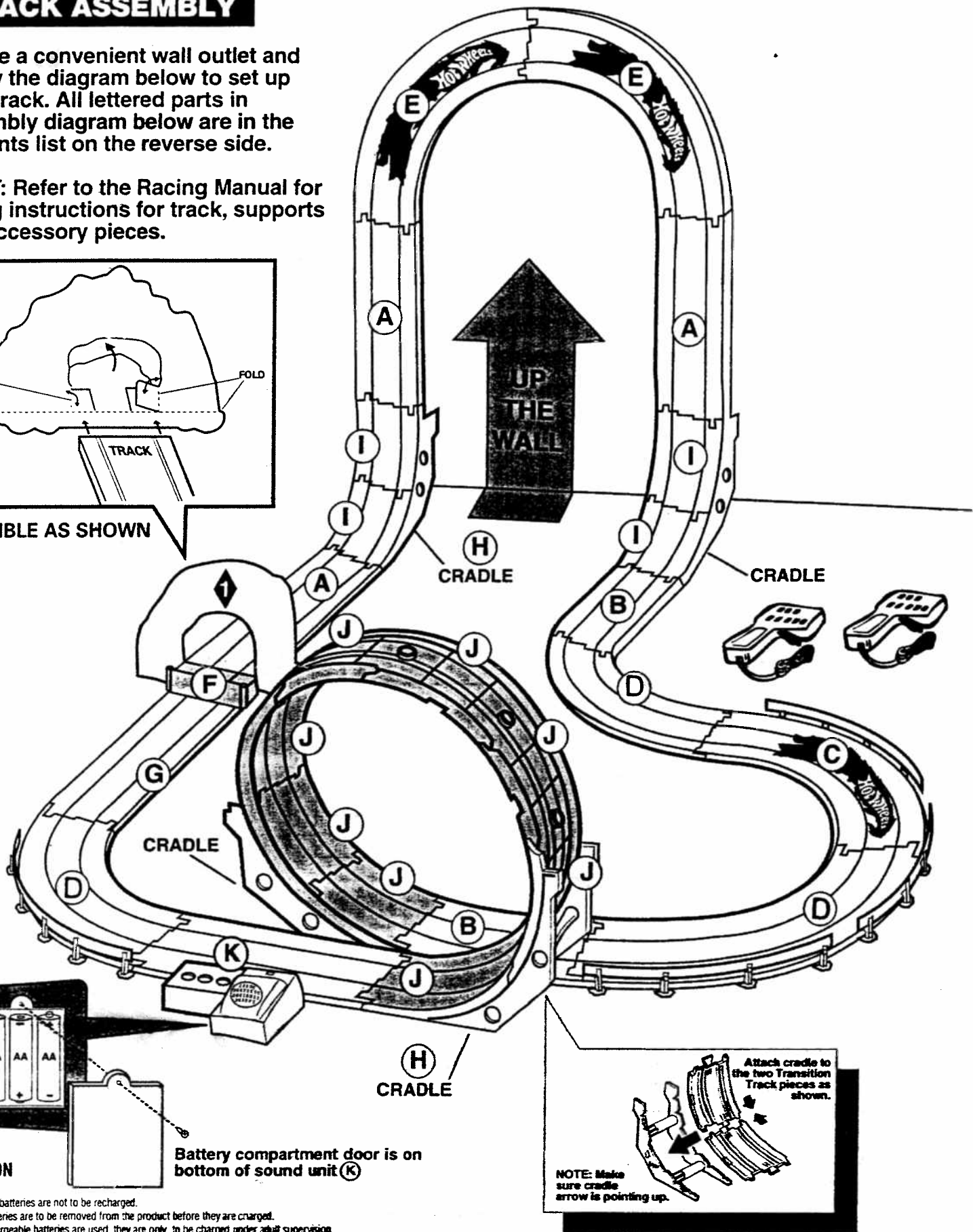

BATTERY INFORMATION

CAUTION:

1. Non-rechargeable batteries are not to be recharged.
2. Rechargeable batteries are to be removed from the product before they are charged.
3. If removable rechargeable batteries are used, they are only to be charged under adult supervision.
4. Do not mix alkaline, standard (carbon-zinc), or rechargeable (nickel-cadmium) batteries.
5. Do not mix old batteries and new batteries.
6. Only batteries of the same or equivalent type as recommended are to be used.
7. Be sure to insert batteries with the correct polarities and always follow the toy and battery manufacturers instructions.
8. Exhausted batteries are to be removed from the product.
9. The supply terminals are not to be short-circuited.
10. Dispose of batteries safely.

Battery compartment door is on bottom of sound unit (K)

NOTE: Make sure cradle arrow is pointing up.

©1999 Mattel, Inc. Mt. Laurel, NJ 08054 U.S.A.
PRINTED IN CHINA. All Rights Reserved.

Mattel, Hot Wheels, flame logo and color "Hot Wheels blue," and other trademarks designated by ® and ™ are trademarks of Mattel, in the U.S. and/or other countries, except as noted. FORD trademark used under license from Ford Motor Company.